

**GasAlert
MicroClipXT**

**GasAlert
MicroClipXL**

**GasAlert
MicroClipX3**

1, 2, 3, and 4 Gas Detector

User Manual

Honeywell

Table of Contents

Introduction	1	Battery Test	15
Zeroing the Sensors	1	Backlight	15
Safety Information - Read First	2	Deactivating the Detector	16
Sensor Poisons and Contaminants	5	Installing Safety Suite Device Configurator.....	16
Getting Started	6	Using Safety Suite DC to Configure the Detector	18
Parts of the GasAlertMicroClip	7	Details	19
Display Elements	8	Serial Number	19
Button	9	Firmware Version	19
Activating the Detector	10	Sensors Configuration	20
Self-Test	10	Sensor Disabled	20
Battery Test	10	Calibration Gas Concentration.....	21
Audible/Visual Test	10	Calibration Interval	21
Detector Version	10	Bump Interval.....	21
Startup Message	10	Low Alarm	22
Alarm Setpoints	11	High Alarm.....	22
Sensor and Power Test	11	TWA Alarm	22
Automatic Zero and O ₂ Calibration (optional)	12	STEL Alarm	22
Calibration Due Date (optional)	12	STEL Interval	23
Last Calibration Failed (optional)	13	Auto Zero on Startup	23
Overdue Calibration	13	O ₂ Auto-Calibration on Startup	
Cal IR Lock	13	(Automatic O ₂ Calibration)	23
Bump Test	13	LEL By Vol CH ₄	23
Last Bump Test Failed	14	Settings	24
Force Bump (optional)	14	Latching Alarms	24
Self-Test Pass	15	Safe Mode	24
Self-Test Fail	15	Startup Message	24

GasAlertMicroClip

User Manual

Stealth Mode 25
Low Alarm Acknowledge 25
Force Calibration When Overdue 26
Cal Lock (Calibration IR Lock) 26
Force Bump When Overdue 26
Confidence Beep 27
IntelliFlash 27
Datalog Interval 28
Confidence Beep and IntelliFlash Interval 28
Language Options 28
Alarms 29
 Computed Gas Exposures 31
 Viewing Gas Exposures 31
 Clearing Gas Exposures 32
 Gas Alarm Setpoints 32
 Factory Gas Alarm Setpoints 33
 Changing Alarm Setpoints 33
 Stopping a Gas Alarm 33
 Sensor Alarm 34
 Low Battery Alarm 34
 Automatic Deactivation Alarm 34
Bump Test 35
Calibration 36
 Guidelines 36
 Diagnostics Test 36

Connecting the Gas Cylinder to the Detector ... 37
Calibration Setup 38
 Setting Span Gas Concentration Values 38
 Connecting to the IR Link 38
 Calibrating with the IR Link 39
 Calibration Procedure 39
 Auto Zero and Oxygen Sensor Calibration 40
 Auto Span 40
 Calibration Due Date 41
 Verification 42
Datalogs 43
Event Logs 43
 Downloading Datalogs and Event Logs 43
 Software Requirements 43
Maintenance 44
 Battery Cautions 44
 Charging the Battery 45
 Replacing a Sensor or Sensor Filter 46
 Removing the back shell 47
 Replacing the Sensor Filter 48
 Replacing the H₂S, CO, and LEL sensor 49
 Replacing the Oxygen Sensor XT and XL 50
 Reassembling the detector 51
Troubleshooting 53
 Startup Troubleshooting 56
 Calibration Troubleshooting 57

Replacement Parts and Accessories 58
Specifications 61
 General Datalogger Specifications 63

GasAlertMicroClip

Introduction

⚠ Warning

To ensure personal safety, read **Safety Information - Read First** and the **Cautions** before using the detector.

The GasAlertMicroClip XT, XL and X3 ("the detector") warns of hazardous gas at levels above user-defined alarm setpoints.

The detector is a personal safety device. It is your responsibility to respond properly to the alarm.

Table 1. lists the gases monitored.

Zeroing the Sensors

To zero the sensors, refer to steps #1-3 in [Connecting to the IR Link](#).

Table 1. Gases Monitored

Gas Detected	Unit of Measure
Hydrogen sulfide (H ₂ S)	parts per million (ppm)
Carbon monoxide (CO)	parts per million (ppm)
Oxygen (O ₂)	percent by volume (%)
Combustible gases (LEL) Field selectable for:	1. percent of lower explosive limit (% LEL) 2. percent by volume methane 0-5.0% v/v

Safety Information - Read First

Use the detector only as specified in this guide and the operator's manual, otherwise the protection provided by the detector may be impaired.

International symbols on the detector and in this manual are explained in [Table 2](#).

Read the **Cautions** on the following pages before using the detector.



This instrument contains a lithium polymer battery. Dispose of lithium cells immediately. Do not disassemble and do not dispose of in fire. Do not mix with the solid waste stream. Spent batteries must be disposed of by a qualified recycler or hazardous materials handler.

⚠ Cautions







- **Warning:** Substitution of components may impair Intrinsic Safety.
- **Before using the detector, refer to [Sensor Poisons and Contaminants](#).**
- **Warning:** For safety reasons, this equipment must be operated and serviced by qualified personnel only. Read and understand the user manual completely before operating or servicing.
- **Do not use the detector if it is damaged. Inspect the detector before using. Look for cracks and/or missing parts.**
- **If the detector is damaged or parts are missing, contact immediately.**
- **Only use sensor(s) that are specifically designed for the GasAlertMicroClip. Refer to [Replacement Parts and Accessories](#).**

GasAlertMicroClip

Safety Information - Read First

- Calibrate the detector before first-time use and then on a regular schedule, depending on use and sensor exposure to poisons and contaminants. Honeywell recommends calibrating at least once every 180 days (6 months).
- Honeywell recommends to “bump test” the sensors before each day’s use to confirm their ability to respond to gas by exposing the detector to a gas concentration that exceeds the alarm setpoints. Manually verify that the audible and visual alarms are activated. Calibrate if the readings are not within the specified limits.
- Honeywell recommends the combustible sensor be checked with a known concentration of calibration gas after any known exposure to catalyst contaminants/poisons (sulfur compounds, silicon vapors, halogenated compounds, etc).
- The combustible sensor is factory calibrated to 50% LEL methane. If monitoring a different combustible gas in the % LEL range, calibrate the sensor using the appropriate gas.
- Caution: High off-scale readings may indicate an explosive concentration.
- Only the combustible gas detection portion of this instrument has been assessed for performance by CSA International.
- Protect the combustible sensor from exposure to lead compounds, silicones, and chlorinated hydrocarbons.
- Sensor exposure to certain organic vapors (such as leaded gasoline and halogenated hydrocarbons) may temporarily inhibit sensor performance. After exposure, a bump test or calibration is recommended.
- For use only in potentially explosive atmospheres where oxygen concentrations do not exceed 20.9% (v/v).
- Any rapid up-scaling reading followed by a declining or erratic reading may indicate a gas concentration beyond upper scale limit, which may be hazardous.
- Only calibrate the detector in a fresh air environment and in a safe area.
- Use only Honeywell approved batteries for the GasAlertMicroClip detector. Refer to [Specifications](#).
- Charge the detector before first-time use. Honeywell recommends the detector be charged after every workday.
- Charge the detector using the recommended charging adapter only. Do not use any other charging adapter. Failure to adhere to this caution can lead to fire and/or explosion.
- Extended exposure of the detector to certain concentrations of combustible gases and air may stress a detector element that can seriously affect its performance. If an alarm occurs due to high concentration of combustible gases, calibrate the detector. If necessary, replace the sensor.
- Do not test the combustible sensor’s response with a butane cigarette lighter; doing so will damage the sensor.
- Do not expose the detector to electrical shock and/or severe continuous mechanical shock.
- Do not attempt to disassemble, adjust, or service the detector unless instructions for that procedure are provided in the technical reference guide, and/or that part is listed as a replacement part. Use only Honeywell replacement parts. Refer to [Replacement Parts and Accessories](#).
- The detector warranty will be voided if customers, personnel, or third parties damage the detector during repair attempts. Non-Honeywell repair/service attempts void this warranty.

Table 2. International Symbols

Symbols	Description
	Approved to both U.S. and Canadian Standards by CSA International
	European Explosive Protection
	Conforms to European Union Directives
ATEX	Conforms to European ATEX Directives
IECEX	International Electrotechnical Commission Scheme for Certification to Standards for Electrical Equipment for Explosive Atmospheres
	Conforms to Korea Testing Laboratory (KTL) Certification
	Natural Institute of Metrology, Quality, and Technology. Conforms to Brazilian INMETRO Certification.
	Australian Regulatory Compliance Mark
	This symbol indicates that the product must not be disposed of as general industrial or domestic waste. This product should be disposed of through suitable WEEE disposal facilities. For more information about disposal of this product, contact your local authority, distributor or the manufacturer.

4

GasAlertMicroClip

Sensor Poisons and Contaminants

Sensor Poisons and Contaminants

Several cleaners, solvents, and lubricants can contaminate and cause permanent damage to sensors. Before using cleaners, solvents, and lubricants in close proximity to the detector sensors, read the following cautions and refer to the lists below.

⚠ Caution

Use only the following Honeywell recommended products and procedures:

- **Use water based cleaners.**
- **Use non-alcohol based cleaners.**
- **Clean the exterior of the detector with a soft, damp cloth.**
- **Do not use soaps, polishes, or solvents.**

Below are common products to avoid using around sensors.

Cleaners and Lubricants

- Brake cleaners
- Lubricants
- Rust inhibitors
- Window and glass cleaners
- Dishsoaps
- Citrus based cleaners
- Alcohol based cleaners
- Hand sanitizers
- Anionic detergents
- Methanol (fuels and antifreezes)

Silicones

- Silicone cleaners and protectants
- Silicone based adhesives, sealants, and gels
- Hand/body and medicinal creams containing silicone
- Tissues containing silicone
- Mold releasing agents
- Polishes

Aerosols

- Bug repellents and sprays
- Lubricants
- Rust inhibitors
- Window cleaners

Getting Started

The list below provides the standard items included with the detector. If the detector is damaged or parts are missing, contact the place of purchase immediately.

- Sensors: H₂S, CO, O₂, and combustible (LEL)
- Calibration cap and hose
- Charging adapter
- Printed Operator's Manual
- Supplementary Booklet, including a Quick Reference Card

Configuration Software: The detector is configured with Safety Suite Device Configurator software. It can be downloaded for free

The detector is shipped with the sensors and rechargeable battery installed.

Battery Replacement: To replace the battery, contact The battery can only be replaced by the manufacturer.

Charge Battery and Replace Sensors: To charge the battery and replace the sensors and/or sensor filter, refer to the following:

- [Battery Cautions](#)
- [Replacing a Sensor or Sensor Filter](#)

To order replacement parts, refer to [Replacement Parts and Accessories](#).

To become oriented with the features and functions of the detector, refer to the following figures and tables:

- [Figure 1.](#) and [Table 3.](#) describes the detector's components.
- [Figure 2.](#) and [Table 4.](#) describes the detector's display elements.
- [Table 5.](#) describes the detector's button.

GasAlertMicroClip

Parts of the GasAlertMicroClip

Parts of the GasAlertMicroClip

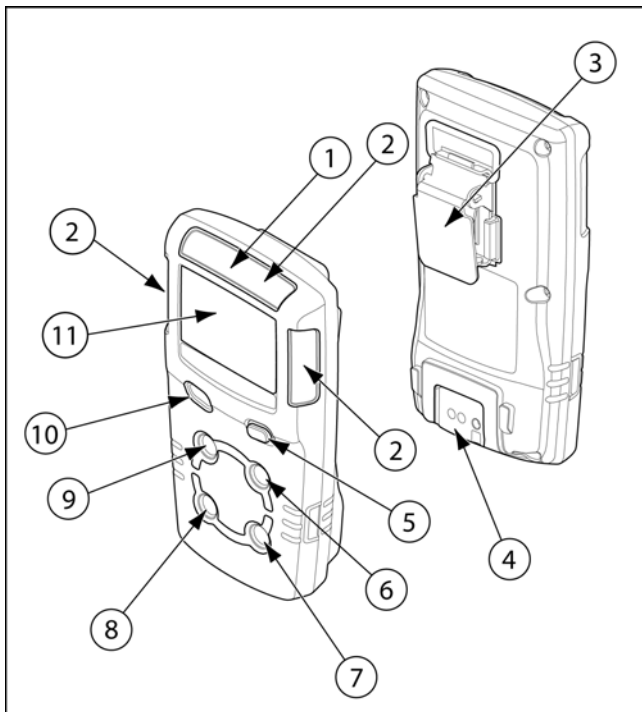

Figure 1. Parts of the GasAlertMicroClip

Table 3. Parts of the GasAlertMicroClip

Item	Description
1	IntelliFlash
2	Visual alarm indicators (LEDs)
3	Alligator clip
4	Charging connector / IR interface
5	Button (○)
6	Carbon monoxide (CO) sensor
7	Hydrogen sulfide (H ₂ S) sensor
8	Oxygen (O ₂) sensor
9	Combustible (LEL) sensor
10	Audible alarm
11	Liquid crystal display (LCD)

Display Elements

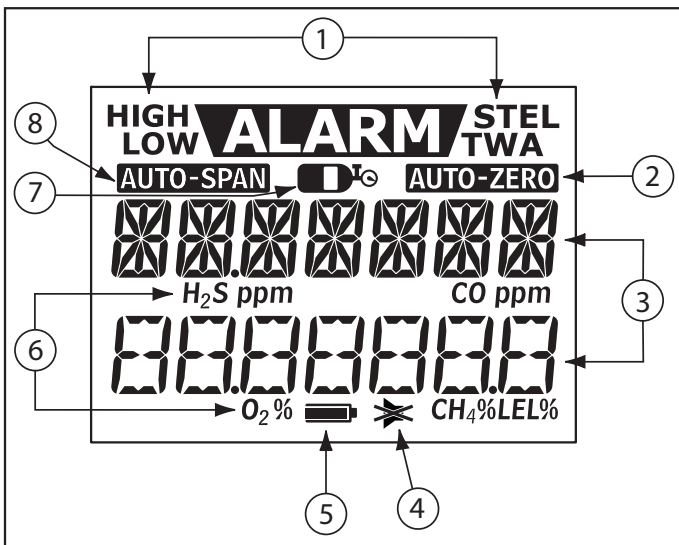

Figure 2. Display Elements

Table 4. Display Elements

Item	Description
1	Alarm condition
2	Automatically zero sensor
3	Numeric value
4	Stealth mode
5	Battery life indicator
6	Gas identifier bars
7	Gas cylinder
8	Automatically span sensor

GasAlertMicroClip
Button

Button

Table 5. Button

Button	Description
	<ul style="list-style-type: none">• To activate the detector press ○.• To deactivate the detector, press and hold ○ until the OFF countdown is complete and the LCD deactivates.• To view the TWA, STEL, and peak (maximum) readings, press ○ twice. To clear the TWA, STEL, and peak readings, press ○ when the LCD displays RESET.• To initiate calibration, deactivate the detector. Press and hold ○ while the detector performs the OFF countdown. Continue holding ○ while the LCD briefly deactivates. The LCD reactivates and then begins the CAL countdown. Release ○ when the CAL countdown is complete.• To activate the backlight in normal operation, press ○.• To acknowledge latched alarms, press ○.• To acknowledge a low alarm and disable the audible alarm, press ○ (if the Low Alarm Acknowledge option is enabled).

Activating the Detector

⚠ Caution

Only activate the detector in a fresh air environment and in a safe area.

To activate the detector, press .

Self-Test

The following startup tests are written as startup performance is intended. If an error occurs, refer to [Startup Troubleshooting](#). When the detector is activated, it performs the following fourteen startup tests: Battery Test, Audible/Visual Test, Detector Version, Startup Message, Alarm Setpoints, Sensor and Power Test, Automatic Zero and O2 Calibration (optional), Calibration Due Date (optional), Last Calibration Failed (optional), Overdue Calibration, Cal IR Lock, Bump Test, Last Bump Test Failed, Force Bump (optional). Confirm these tests occur.

1. Battery Test

The detector performs a battery test during startup. If the battery has insufficient power to operate, the following screen displays.

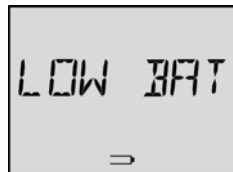

Charge the battery for 2-3 hours before restarting the detector. Refer to [Charging the Battery](#).

2. Audible/Visual Test

All of the LCD elements display simultaneously as the detector beeps, flashes, vibrates, and activates the backlight.

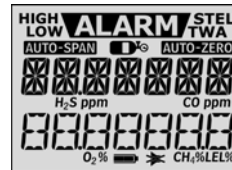

3. Detector Version

The current firmware version of the detector then displays on the LCD.

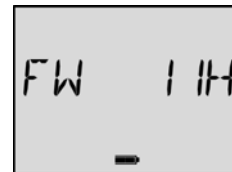

4. Startup Message

You can enter up to two-25 character lines in the **Startup Message** via Safety Suite Device Configurator. The first line accepts alphanumeric characters; the second line only accepts digits.

Refer to [Detector Identification Section](#)

GasAlertMicroClip

Activating the Detector

5. Alarm Setpoints

Next, the TWA, STEL, low, and high alarm setpoints display.

Note

Alarm setpoints may vary by region. Refer to [Factory Gas Alarm Setpoints](#).

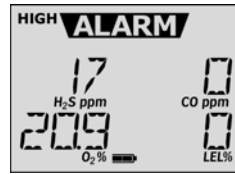
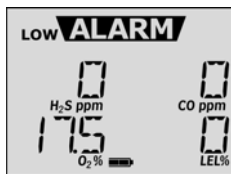
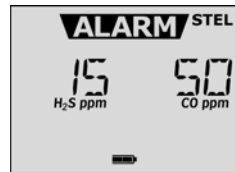
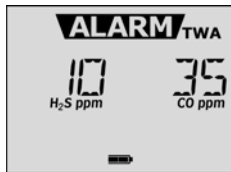

6. Sensor and Power Test

The detector then tests the sensors.



After testing the sensors, the following screen displays to verify all sensors have passed.



If an error message displays, refer to [Startup Troubleshooting](#).

Note

The sensors are tested continuously while the detector is activated.

7. Automatic Zero and O₂ Calibration (optional)

Auto-Zero on Startup: If enabled, the H₂S, CO, and LEL sensors are automatically zeroed during startup. Each sensor is enabled individually. The auto-zero option is enabled for each sensor upon shipment.

O₂ Auto-Calibration on Startup: If enabled, the O₂ sensor is automatically calibrated during startup. The auto-calibration option is enabled for the O₂ sensor upon shipment.

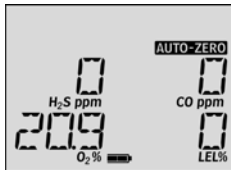

If the **O₂ Auto-Calibration on Startup** option is enabled, and the **Auto-Zero on Startup** option is disabled for all sensors, the following screen displays.

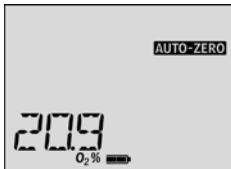

Note

If oxygen is configured to measure 20.8% vol., the oxygen calibration screen displays **20.8% O₂**.

8. Calibration Due Date (optional)

The following screen displays the number of days remaining before calibration is due. The number of days that displays is when the next sensor calibration should be performed.



Note

If the **Calibration Interval** option is defined as **0**, the calibration due date is bypassed during startup.

GasAlertMicroClip

Activating the Detector

9. Last Calibration Failed (optional)

If any sensor failed the last calibration, **CAL FAILURE** displays on the screen.

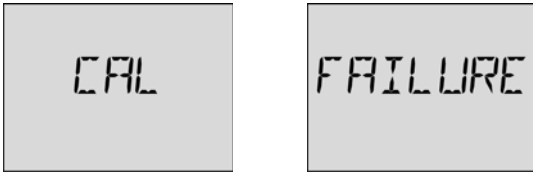

Note

When the CAL FAILURE displays, the previous calibration has failed but the calibration is still valid until the next calibration due date.

10. Overdue Calibration

If any sensor is past due for calibration, the detector beeps, flashes, vibrates, and the following screen displays.



If calibration is overdue and the **Force Calibration When Overdue** option is enabled, a calibration must be performed to enter normal operation. Refer to [Calibration](#).

Note

If calibration is not performed, or \circ is not pressed within 2 minutes, the detector automatically deactivates.

If the **Force Calibration When Overdue** is disabled, press \circ to acknowledge the warning. The detector continues with the startup self-tests and then enters normal operation.

11. Cal IR Lock

If the **Cal Lock** option is enabled, the following screen displays.



Refer to [Startup Troubleshooting](#).

12. Bump Test

Note

A bump test cannot be conducted if the detector has just been calibrated. If the **Bump Interval** option is defined as **0** in *Safety Suite Device Configurator*, the bump test is bypassed.

Honeywell recommends to “bump test” the sensors, before each day’s use, to confirm their ability to respond to gas by exposing the detector to a gas concentration that exceeds the alarm setpoints.

13. Last Bump Test Failed

If any sensor failed the last calibration, **CAL FAILURE** displays on the screen.

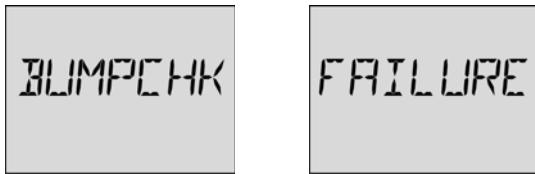

Note

When the **BUMPCHK FAILURE** displays, the previous calibration has failed but the calibration is still valid until the next bump test due date.

14. Force Bump (optional)

If the **Force Bump** option is enabled and the sensors are due to have a bump test, the following screen displays.



A bump test must be performed to enter normal operation. Apply gas to the sensors. Ensure the visual, audible, and vibrator alarms activate. When the gas is removed, the detector briefly remains in alarm until the gas has cleared from the sensors.

When the sensors successfully pass the bump check, the following screen displays showing the number of days remaining until the next bump check is due (**1 d** = 1 day).



If **Force Bump** is disabled, press **○** to continue with the startup self-tests.

Note

If **BUMPCHK todAY** displays again after performing a bump check, refer to [Startup Troubleshooting](#).

GasAlertMicroClip

Activating the Detector

Self-Test Pass

When the detector has passed all startup self-tests, it enters normal operation. The LCD displays the ambient gas readings.

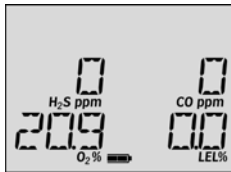

The detector automatically begins

- recording the peak (maximum) gas exposure,
- calculating the short-term exposure level (STEL), and
- calculating the time-weighted average (TWA) exposures.

Self-Test Fail

If the following error message displays after entering normal operation, refer to [Startup Troubleshooting](#).

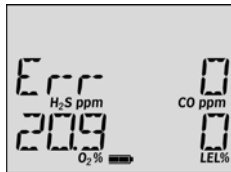

Battery Test

The battery is tested when the detector is activated and continuously thereafter. See Specifications for Battery Runtimes.

- Battery power is continually displayed during normal operation. If battery power is low, **ALARM** and  flashes. The detector performs a sequence of 10 rapid sirens and alternating flashes with 7 seconds of silence in between (continues for 15 minutes).
- If battery power becomes critically low, **ALARM** and **LOW BAT** display. The detector performs a sequence of 10 rapid sirens with 1 second of silence in between (sequence reactivates seven times). The detector then displays **OFF** and the detector deactivates.

Note

If enabled, **Confidence Beep** and **IntelliFlash** automatically deactivate during a low battery alarm. Refer to [Confidence Beep](#)

Backlight

The backlight automatically activates

- during startup,
- when the button is pressed (then deactivates after 5 seconds), and
- when there is an alarm condition (unless **Stealth** is enabled).

Deactivating the Detector

To deactivate the detector, press and hold . The detector

- performs a sequence of two sirens with alternating flashes,
- vibrates,
- initiates the deactivation countdown, and
- displays **OFF**.



Note

If  is released before the countdown is complete, the detector will not deactivate.

Installing Safety Suite Device Configurator

Safety Suite Device Configurator is required to configure the detector and sensors. And IR Link is also required.

To install Safety Suite Device Configurator complete the following:

1. Download Safety Suite Device Configurator
2. Follow the installation wizard.
3. When installation is complete, open Safety Suite Device Configurator.
4. Enter the Username and Password (password is case sensitive).



GasAlertMicroClip

Installing Safety Suite Device Configurator

5. Click **LOG IN**
6. Plug in your device via IntelliDoX or AutoRAE 2. For further reference and information about the instruments to connect to your computer, refer to the Safety Suite Device Configurator User Guide
Once the device is plugged into the computer, it should be shown in the home page under the **tab Device List View**.
7. This list will show all devices that have been plugged at some time, whether they are currently plugged or not.
8. Safety Suite Device Configurator displays the device's information that includes the following sections.
 - Serial number
 - Device Type
 - Model Number
 - Assigned Worker
 - Location
 - Last Successful Bump
 - Last Downloaded Date/Log Date
 - Device Status
 - Brand

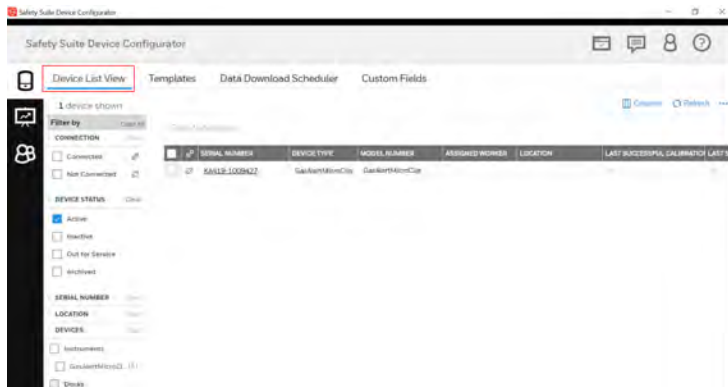

Using Safety Suite Device Configurator to Configure the Detector

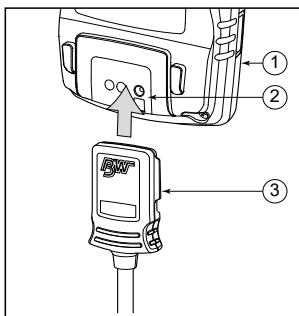

Table 6: Connecting to the IR Link

Item	Description
1	Detector
2	IR and charger interface
3	IR Link

6. Click on the device's name to view all the information.
7. Three tabs are available: Details, Sensors, and Settings.
8. Refer to the descriptions in the following sections to define settings and enable/disable options:
 - Details
 - Sensors Configuration (CO, O2, H2S, and LEL)
 - Settings
9. When configuration of new settings is complete, click **Save** at the bottom of the window. The detector automatically updates with the new settings.

1. Activate the detector and wait for the startup tests to complete.
2. Connect the USB cable to the USB port on the computer.
3. Connect the USB cable to the IR Link.
4. Insert the IR link onto the IR interface on the back of the detector.
5. Open Safety Suite Device Configurator. If the device does not appear at the home screen after Login, click **Refresh** on the top right corner. Refer to [Installing Safety Suite Device Configurator](#).

GasAlertMicroClip

Details

Details

The **Details** section provides information about the detector and current firmware version. Assignments can be made for worker and location, settings can be established for Bump Test and for Calibration.

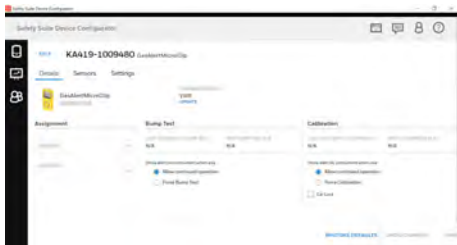

Figure 3. Details

Serial Number

The serial number is visible on the top of the screen. It is also located on the back of the detector. The serial number is listed next to the **S:** QR code. This cannot be altered.

Note

GasAlertMicroClip serial numbers use the KA serial number prefix.

Firmware Version

Firmware Version cannot be altered but it can be updated. The field automatically populates when data is retrieved from the detector. If new firmware is downloaded to the detector, the field automatically updates when data is retrieved.

The firmware version displays on the detector LCD during the startup self-tests.

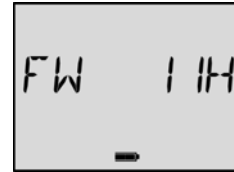

Sensors Configuration

Settings for the sensors are configured individually. Enter values or enable/disable options. Refer to [Factory Gas Alarm Setpoints](#) for setpoint values.

Note

Depending upon the sensor, the options may vary.

Sensor Disabled

⚠ Warning

Use extreme caution when disabling a sensor. The disabled sensor cannot detect and alarm against the applicable gas.

1. Click the edit button of the gas to be disabled.
2. Click the **Enable Sensor** checkbox for the required sensor.



Figure 4. CO Sensor Configuration

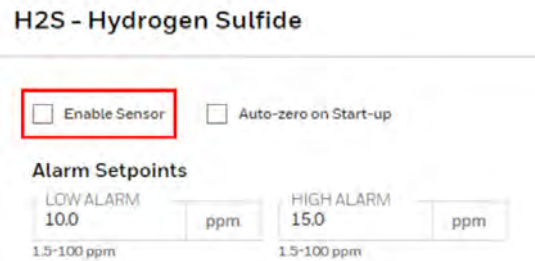
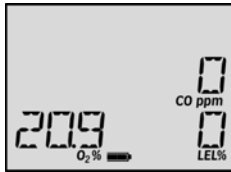

Figure 5. Disabled Sensor

GasAlertMicroClip Sensor Configuration

3. Click the **Save** button located at the bottom of the window. The detector LCD automatically updates. The gas type and sensor readings no longer display on the LCD for the applicable sensor.



5. Enable the sensor as soon as possible. If the sensor is damaged, replace it immediately. Refer to [Replacing a Sensor or Sensor Filter](#).

Calibration Gas Concentration

⚠ Caution

The gas concentration value entered in Safety Suite Device Configurator must match the gas concentration value on the gas cylinder.

1. Refer to the following list of recommended gas mixtures:
 - CO: 100 ppm balance N₂
 - H₂S: 25 ppm balance N₂
 - LEL: 50% LEL or 2.5% by vol. methane balance air
 - O₂: 20.9% balanced with N₂
2. Select/enter the gas concentration value in the **Calibration Gas** field of the applicable sensor.

Calibration Interval

⚠ Caution

Honeywell recommends that the sensors be calibrated once every 180 days (6 months).

Define how often a sensor should be calibrated in the **Intervals-Calibration** field. A different calibration interval can be defined for each sensor.

1. Enter the value (**0-365** days) for each sensor.
2. Enter **0** to disable the calibration interval option. Entering zero automatically deactivates the **Force Calibration When Overdue** user option.

The detector is shipped with the factory default set to **180** days.

Bump Interval

Define how often a bump check should be performed for each sensor in the **Intervals- Bump Test** field. A different bump interval can be defined for each sensor.

1. Enter the value (**0-365** days) for each sensor.
2. Enter **0** to disable the **Bump Interval** option. Entering **0** automatically disables the **Force Bump When Overdue** option.

The detector is shipped with the factory default set to **0** days.

Note

Honeywell recommends to bump test the sensors before each day's use to confirm their ability to respond to gas by exposing the detector to a gas concentration that exceeds the alarm setpoints. Verify that the audible and visual alarms activate. Calibrate if the readings are not within the specified limits.

Low Alarm

Enter the low alarm setpoints for each sensor. Refer to [Factory Gas Alarm Setpoints](#) for factory defined alarm setpoints.

Applicable to all sensors.

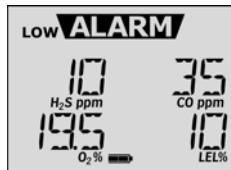

High Alarm

Enter the high alarm setpoints for each sensor. Refer to [Factory Gas Alarm Setpoints](#) for factory defined alarm setpoints.

Applicable to all sensors.

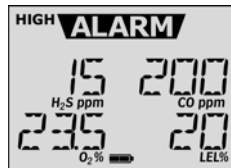

TWA Alarm

The time-weighted average (TWA) is a safety measure used to determine accumulated average exposure to gases. An average is determined using the US Occupational Safety and Health Administration (OSHA) method to ensure the worker is warned when the maximum average is accumulated.

The US OSHA method is defined as a moving average that accumulates over an 8-hour average. If the worker is in the field longer, the oldest accumulated values (first hour) are replaced by the newest values (ninth hour). This continues for the duration of the work shift until the detector is deactivated.

TWA Alarm applies to CO and H₂S sensors only.

1. Refer to [Factory Gas Alarm Setpoints](#) for the factory alarm setpoints.
2. Enter the setpoint in the **TWA Alarm** field.

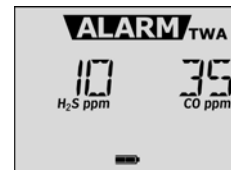

STEL Alarm

The short-term exposure limit (STEL) is the maximum permissible gas concentration a worker can safely be exposed to for short periods of time (5-15 minutes maximum).

STEL Alarm applies to CO and H₂S sensors only.

Note

Standard factory Alarm Setpoints vary by region. Refer to [Factory Gas Alarm Setpoints](#) for OSHA factory settings.

1. Refer to the applicable regulatory requirements in your area for defining STEL alarm setpoints.

GasAlertMicroClip Sensor Configuration

2. Enter the setpoint for the CO and H₂S sensor in the **STEL Alarm** field. Proceed to STEL Interval.

STEL Interval

STEL Interval provides protection for workers from over exposure to high concentrations of gas, and is based on user-defined **5-15** minute intervals. When the maximum STEL is reached, the detector alarms to notify the worker.

⚠ Caution

Follow all safety procedures as defined by your employer.

Enter the interval (**5-15** minutes) in the **STEL Interval** field. The detector is shipped with the factory default setting of **15** minutes.

Auto Zero on Startup

When enabled, the sensors automatically zero during the startup self-tests. The **Auto-Zero on Start-up** option is available for the CO, H₂S, and LEL sensors. Not applicable to O₂.

1. Click the checkbox of each sensor that will be auto zeroed during startup.

The detector is shipped with the **Auto-Zero on Start-up** option enabled for the CO, H₂S, and LEL sensor.

O₂ Auto-Calibration on Startup (Automatic O₂ Calibration)

When enabled, the O₂ sensor is automatically calibrated during the startup self-tests.

The detector is shipped with the **O₂ Auto-Calibration on Startup** option enabled.

LEL By Vol CH₄

When enabled, the detector displays the LEL value as **CH₄%**, assuming a methane environment.

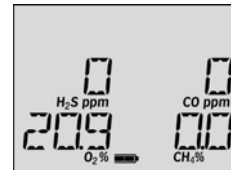

The **LEL By Vol CH₄** option is applicable to the LEL sensor only. The detector is shipped with the **LEL by Vol CH₄** disabled.

Settings

The settings section provides detector features that can be enabled or disabled. The blue checkmark indicates the option is enabled. Click the checkbox to disable the option.

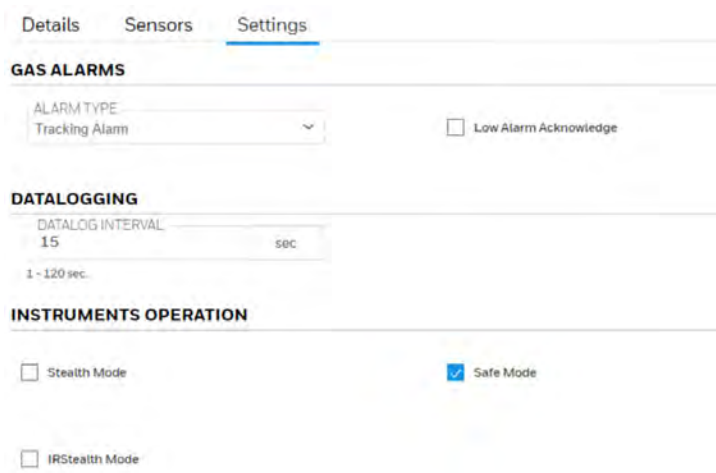



Figure 6. Safety Suite Device Configurator Settings

Latching Alarms

When enabled, a low alarm persists until the alarm is acknowledged and gas concentrations are below the low alarm setpoint. The audible alarm can be temporarily deactivated by pressing , but the LCD continues to display the peak concentration values until the alarm condition no longer exists.

The detector is shipped with **Latching Alarms** disabled.

Safe Mode

When enabled, **SAFE** displays continuously on the LCD unless an alarm condition occurs. **Safe Mode** provides visual confirmation that no (monitored) hazardous gas is present.



The detector is shipped with **Safe Mode** disabled.

Startup Message

Enter text (25 characters per line to display on the detector LCD during startup. Enter information such as employee name, plant, area, emergency numbers, etc. The first line accepts alphanumeric characters; the second line only accepts digits.

Depending upon the length of the message, it will either

- a) display on the LCD for 3 seconds (shorter message), or
- b) scroll twice on the LCD (longer message).

GasAlertMicroClip

User Options

Stealth Mode

When enabled, the backlight, visual alarms, and audible alarms are disabled.  displays continuously on the LCD.

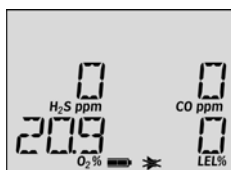

During an alarm, the vibrator activates and readings display on the LCD. The detector is shipped with **Stealth Mode** disabled.

Low Alarm Acknowledge

When enabled, the audible alarm can be deactivated during a low alarm for the CO, H₂S, and LEL sensors. The LED and visual alarm indicators remain active until the alarm condition changes or the detector deactivates.

Press  to acknowledge the low alarm and deactivate the audible alarm.

Note

Low Alarm Acknowledge is not applicable to O₂.

The detector is shipped with **Low Alarm Acknowledge** disabled.

Force Calibration When Overdue

When enabled, if a sensor(s) is past due, the sensor(s) must be calibrated immediately, otherwise the detector deactivates.

Enable **Force Calibration When Overdue** to ensure calibrations are performed regularly and sensors are operating correctly. The following screen displays during the startup sequence when the option is enabled and the sensor(s) is overdue.



To enable **Force Calibration When Overdue**, complete the following:

1. Click the **Force Calibration When Overdue** checkbox to enable.
2. Enter a value (1-365 days) in the Calibration Interval (**Cal Interval**) field.

⚠ Caution

If 0 (zero) is entered in the Cal Interval field, the Force Calibration When Overdue option is automatically disabled.

The detector is shipped with **Force Calibration When Overdue** disabled.

For more information, refer to [Calibration](#).

Cal Lock (Calibration IR Lock)

When enabled, the sensors can only be calibrated using an infrared (IR) device to ensure calibrations are recorded. The following are IR devices:

- IR Link with Safety Suite Device Configurator (refer to [Connecting to the IR Link](#)).
- IntelliDoX docking module (refer to the *IntelliDoX User Manual*).

If **Cal Lock** is enabled and calibration is attempted, the following screen displays.



Note

*If **Cal Lock** is enabled, the detector will still auto zero the sensors.*

*The detector is shipped with **Cal Lock** disabled.*

Force Bump When Overdue

When enabled, if a sensor(s) is past due for a bump test, the sensor(s) must be bump tested immediately, otherwise the detector deactivates.

A bump test should be performed regularly to ensure the sensors are responding correctly to gas. The following screen displays when the option is enabled and the sensor(s) is overdue.



To enable **Force Bump When Overdue**, complete the following:

1. Click the **Force Bump When Overdue** checkbox to enable.
2. Enter a value (**1-365** days) in the Bump Interval field.

⚠ Caution

If 0 is entered in the Bump Interval field, the Force Bump When Overdue option is automatically disabled.

The detector is shipped with **Force Bump When Overdue** disabled.

For information and procedures, refer to Bump Test.

Confidence Beep

When enabled, the confidence beep provides continuous audible confirmation that the detector is operating correctly by beeping once every second.

Note

Confidence beep automatically disables during a low battery alarm, a self-test fail, a calibration fail, a bump test fail, or during an alarm event.

To define how often Confidence Beep occurs (**1-60** seconds), refer to Confidence Beep and IntelliFlash Interval. Default setting is 1 second.

The detector is shipped with the **Confidence Beep** disabled.

IntelliFlash

When enabled, the green LED flashes to provide continuous visual confirmation that the detector is operating correctly.

Note

IntelliFlash is only applicable to GasAlertMicroClip XT, XL and X3.

IntelliFlash automatically deactivates during a low battery alarm, a self-test fail, a calibration fail, a bump test fail, or during an alarm event.

To define how often IntelliFlash occurs (**1-60** seconds), refer to Confidence Beep and IntelliFlash Interval. Default interval is **1** second.

The detector is shipped with **IntelliFlash** enabled.

Datalog Interval

Enter a value (**1-120** seconds). The default datalog interval is one reading every **15** seconds.

Confidence Beep and IntelliFlash Interval

Enter a value (**1-60** seconds) to define how often IntelliFlash occurs and the detector beeps. IntelliFlash and/or Confidence Beep must be enabled in order to define Confidence Beep and IntelliFlash Interval.

Refer to Confidence Beep and IntelliFlash Interval. Default interval is **1** second.

Note

IntelliFlash and IntelliFlash Interval are only applicable to GasAlertMicroClip XT, XL and X3.

Language Options

The detector can display warnings and notifications in five different languages. Choose the desired language from the **Settings** tab. Refer to the following illustration.

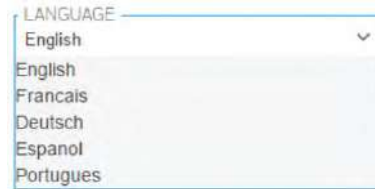

Click a language. When the settings are saved to the detector, the LCD displays warnings and notifications in the selected language.

The detector is shipped with **English** as the default language.

GasAlertMicroClip
Alarms

Alarms

Table 7. describes the detector alarms and corresponding screens. During an alarm condition, the detector activates the backlight, audible/visual/vibrator alarms, and displays the current ambient readings. If more than one type or level of alarm occurs simultaneously, a multi-gas

alarm results. If Stealth is enabled, the audible and visual alarms are disabled, and only the vibrator alarm activates.

To change the factory-defined alarm setpoints, refer to [Low Alarm](#), [High Alarm](#), [TWA Alarm](#), and [STEL Alarm](#).

Table 7. Alarms







Alarm	Screen	Alarm	Screen
<p>Low Alarm</p> <ul style="list-style-type: none"> • Slow siren • Slow alternating flash • ALARM and gas bar flash • Vibrator alarm activates 		<p>TWA Alarm</p> <ul style="list-style-type: none"> • Slow siren • Slow alternating flash • ALARM and gas bar flash • Vibrator alarm activates 	
<p>High Alarm</p> <ul style="list-style-type: none"> • Fast siren • Fast alternating flash • ALARM and gas bar flash • Vibrator alarm activates 		<p>STEL Alarm</p> <ul style="list-style-type: none"> • Fast siren • Fast alternating flash • ALARM and gas bar flash • Vibrator alarm activates 	

Note

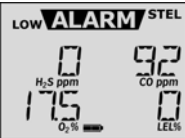
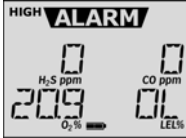
If **Low Alarm Acknowledge** is enabled, the audible alarm can be disabled during a low alarm condition. The vibrator and visual alarm indicators remain active until the alarm condition changes or the detector deactivates. Press to acknowledge the low alarm and deactivate the audible alarm. If the alarm escalates to a high, TWA, or STEL alarm, the audible alarm reactivates.

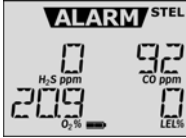
If enabled, **Latched Alarms** causes the low and high gas alarms (audible, visual, and vibrator) to persist until the alarm is acknowledged (by pressing) and the gas concentration is

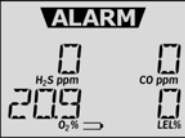
below the low alarm setpoint. The LCD displays the peak concentration and the audible, visual, and vibrator indicators persist until the alarm condition no longer exists. Enable/disable **Latching Alarms** in Safety Suite Device Configurator. Local regulations may require **Latching Alarms** be enabled.

Alarm	Screen	Alarm	Screen
Multi-Gas Alarm <ul style="list-style-type: none"> Sequence alternating low and high alarm siren and flash ALARM and gas bars flash Vibrator alarm activates 		Over Limit (OL) Alarm <ul style="list-style-type: none"> Fast siren and alternating flash ALARM and gas bar flash Vibrator alarm activates OL displays 	
Sensor Alarm <ul style="list-style-type: none"> During startup sequence Error [sensor name] displays During normal operation Err displays (must be acknowledged by press ○) 		Confidence Beep and IntelliFlash <ul style="list-style-type: none"> One beep and flash every second <p><i>Note</i> The detector is shipped with Confidence Beep disabled and IntelliFlash enabled</p>	
Low Battery Alarm <ul style="list-style-type: none"> Sequence of 10 rapid sirens and alternating flashes with 7 seconds of silence in between (continues for 15 minutes)  and ALARM flash, LOW BAT displays, and the vibrator alarm activates After 15 minutes, of the Low Battery alarm, the Automatic Shutdown Alarm sequence begins OFF displays before deactivating 		Automatic Shutdown Alarm <ul style="list-style-type: none"> Sequence of 10 rapid sirens and alternating flashes with 1 second of silence in between (sequence reactivates seven times) LOW BAT and ALARM display Vibrator alarm activates OFF displays before deactivating 	
		Normal Shutdown <ul style="list-style-type: none"> Sequence of two sirens and alternating flashes Vibrator alarm activates Countdown initiates OFF displays 	

GasAlertMicroClip
Alarms

Computed Gas Exposures

⚠ Warning

To avoid possible personal injury, do not deactivate the detector during a work shift. TWA, STEL, and MAX readings reset once the detector is deactivated.

Table 8. Computed Gas Exposures

Gas Exposures	Description
TWA (H ₂ S and CO only)	Time-weighted average (TWA) based on accumulated exposure to toxic gases averaged over a workday according to US OSHA method. OSHA: 8 hour moving average
STEL (H ₂ S and CO only)	Short-term exposure limit (STEL) to gas based on a 5-15 minute user-defined period.
Peak* (maximum)	Peak concentration encountered during work shift.

* For oxygen, it is the highest or the lowest concentration encountered.

Viewing Gas Exposures

To view the TWA, STEL, and peak (maximum) readings, press **○** twice. The LCD first displays the TWA gas exposures.

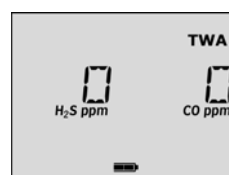

Then the LCD displays the STEL gas exposures.

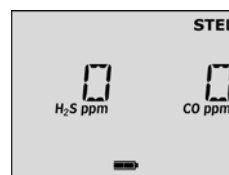

Finally the LCD displays the peak (maximum) readings.

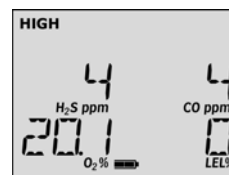

Clearing Gas Exposures

⚠ Caution

Follow all safety procedures as defined by your employer. Confirm with your supervisor before clearing TWA and STEL alarms.

To clear the TWA, STEL, and peak exposure readings, press **○** when the LCD displays **RESET**.



Gas Alarm Setpoints

Gas alarms are activated when detected gas concentrations are above or below the user-defined setpoints. Gas alarms are described below.

Table 9. Gas Alarm Setpoints

Alarm	Condition
Low	<i>Toxics and combustibles:</i> Ambient gas level above low alarm setpoint. <i>Oxygen:</i> Ambient gas level may be set above or below 20.9% (or 20.8%).
High	<i>Toxics and combustibles:</i> Ambient gas level above high alarm setpoint. <i>Oxygen:</i> Ambient gas level may be set above or below 20.9% (or 20.8%).
TWA	<i>Toxics only:</i> Accumulated value above the TWA alarm setpoint.
STEL	<i>Toxics only:</i> Accumulated value above the STEL alarm setpoint.
Downscale	<i>Toxics only:</i> If sensor reading is negative (half of the TWA setpoint)
Multi-gas	Two or more gas alarm conditions.

GasAlertMicroClip
Alarms

Alarm	Condition
Over Limit (OL)	OL displays when readings are above or below the sensor detection range. Refer to Specifications for detection ranges.

Factory Gas Alarm Setpoints

Note

Standard factory alarm setpoints may vary by region.

[Table 10](#) lists the factory alarm setpoints as defined by Occupational Safety and Health Association (OSHA).

Table 10. Sample Factory Alarm Setpoints

Gas	TWA	STEL	Low	High
O ₂	N/A	N/A	19.5% vol.	23.5% vol.
LEL	N/A	N/A	10% LEL	20% LEL
CO	35 ppm	50 ppm	35 ppm	200 ppm
H ₂ S	10 ppm	15 ppm	10 ppm	15 ppm

Changing Alarm Setpoints

To change alarm setpoints, use the docking module or IR Link and refer to the following under [Sensor Configuration](#):

- [Low Alarm](#)
- [High Alarm](#)
- [TWA Alarm](#)
- [STEL Alarm](#)

Stopping a Gas Alarm

The low and high alarms stop when the ambient gas concentration returns to the acceptable range.

Note

If alarms are set to latch, press  to reset the alarms.

The detector calculates the TWA value based on OSHA standards and the STEL value based on a user-defined 5 to 15 minute period. Refer to [STEL Interval](#).

To stop a TWA or STEL alarm, perform one of the following:

1. Deactivate and reactivate the detector.
2. Reset the TWA/STEL/peak exposure readings. Refer to [Viewing Gas Exposures](#).

 Warning

Follow all safety procedures as defined by your employer. Confirm with your supervisor before clearing TWA and STEL alarms.

Sensor Alarm

The detector tests for missing or defective sensors during the startup self-test and continuously thereafter.

- During start-up if a sensor fails, **Err** and the sensor name displays.
- If a sensor fails the self-test, **Err** displays above the gas type of the failed sensor. The detector will enter alarm. Press \bigcirc to acknowledge the sensor alarm and stoop the alarm. Refer to [Troubleshooting](#).

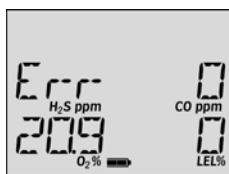

Low Battery Alarm

- Battery power is continually displayed during normal operation. If battery power is low, **ALARM** and --- flashes. The detector performs a sequence of 10 rapid sirens and alternating flashes with 7 seconds of silence in between (continues for 15 minutes).

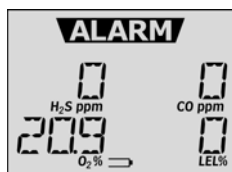

- If battery power becomes critically low, **ALARM** and **LOW BAT** display. The detector performs a sequence of 10 rapid sirens with 1 second of silence in between (sequence reactivates seven times). The detector then displays **OFF** and the detector deactivates.

Charge the battery immediately. Refer to [Charging the Battery](#).

Note

Confidence Beep automatically disables during a low battery alarm.

Automatic Deactivation Alarm

An automatic deactivation alarm will occur if

- the battery voltage is too low to operate the detector,
- calibration is due but not performed (when the **Force Calibration** option is enabled),
- bump test is due but not performed (when the **Force Bump** option is enabled) and
- all sensors fail during the startup self-test.

The detector performs a sequence of 10 rapid sirens with alternating flashes with 1 second of silence in between (sequence reactivates seven times). **OFF** then displays and the detector deactivates.

Bump Test

Gas Cylinder Guidelines (Bump Test)

- To ensure an accurate bump check, use a premium-grade gas. Use gases approved by the National Institute of Standards and Technology.
- Do not use a gas cylinder that is past its expiration date.

Gas Cylinder Connection

1. Connect the calibration hose to the 0.5 l/min regulator on the gas cylinder. For use with the IntelliDoX, use a demand flow regulator.

NOTE: Cylinders that are used with a demand flow regulator must meet the following maximum inlet pressure specifications:

- Disposable cylinders 0-1000 psig/70 bar
- Refillable cylinders 0-3000 psig/207 bar

To perform an automated bump check, refer to the *IntelliDoX User Manual*.

2. Connect the calibration hose to the calibration cap.
3. Attach the calibration cap to the detector.
4. Apply gas. Verify the visual and audible alarms activate.
5. Close the regulator and remove the calibration cap from the detector.
NOTE: The detector will temporarily remain in alarm until the gas clears from the sensors.
6. Disconnect the hose from the calibration cap and the regulator.

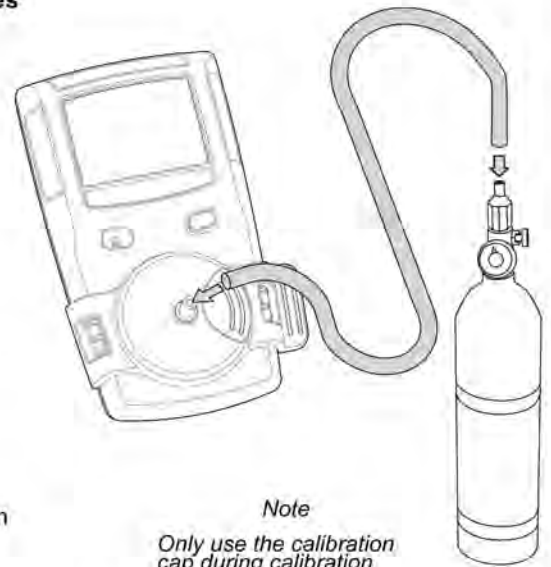

Calibration

Guidelines

When calibrating the detector, adhere to the following guidelines:

- Recommended gas mixture:
CO: 100 ppm balance N₂
H₂S: 25 ppm balance N₂
LEL: 50% LEL or 2.5% for NA (2.2% for EU) by vol. methane balance air
O₂: 18% by volume, balance N₂.
- To ensure accurate calibration, use a premium-grade calibration gas. Gases approved by the National Institute of Standards and Technology (NIST) improve the accuracy of the calibration.
- Do not use a gas cylinder past its expiration date.
- Calibrate a new sensor before use. Install the sensor, activate the detector, and allow the sensor to stabilize before starting calibration (used sensor: 60 seconds / new sensor: 5 minutes, for X3 O₂ stabilization takes 60 minutes).
- Calibrate the sensors at least once every 180 days, depending on use and sensor exposure to poisons and contaminants.
- Calibrate the detector if the gas readings varies during startup.
- Calibrate the sensor before defining the alarm setpoints. **8**
- Calibrate only in a safe area that is free of hazardous gas in an atmosphere of 20.9% oxygen.
- Do not calibrate the detector during or immediately after charging is complete.
- The oxygen sensor can be automatically calibrated each time upon activation (if this feature is enabled). Activate the detector in a normal (20.9%/20.8% oxygen) atmosphere.

- Allow the detector to stabilize for 1 minute after activation before performing a calibration or bump test.
- If a certified calibration is required, contact .

Diagnostics Test

The detector tests the air (auto zero) and the span gas that is applied (auto span) to ensure it meets expected values. Auto zero sets the zero-gas level of the sensor.

Auto Zero: If target gas is present, the zero level will be incorrect and the sensor will fail. If a sensor fails, an error message displays.



Auto Span: If the target gas does not meet expected values, an error message displays.



A sensors that fails to span retains the previous span value, and does not continue with the calibration process.

GasAlertMicroClip
Calibration

Connecting the Gas Cylinder to the Detector

Refer to the following [Figure 7](#), [Table 11](#), and procedures to connect the gas cylinder to the detector for calibration.

Note

Wind currents may cause false readings and poor calibrations.

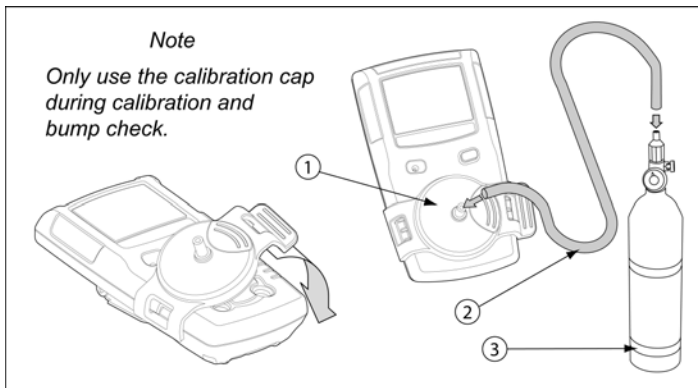

Figure 7. Connecting the Gas Cylinder to the Detector

Table 11. Connecting the Gas Cylinder to the Detector

Item	Description
1	Calibration cap
2	Calibration hose
3	Gas cylinder with 0.5 ml/min regulator

Read the following steps (1-7) before beginning calibration.

1. Verify the calibration gas being used matches the span concentration value(s) that are set for the detector. Refer to **Calibration Gas** in Safety Suite Device Configurator.
2. Attach a 0.5 ml/min regulator to the gas cylinder. To perform an automated calibration, use a demand flow regulator and refer to the *IntelliDoX User Manual*.
3. Connect the calibration hose to the calibration cap.
4. Connect the other end of the calibration hose to the regulator on the gas cylinder.
5. Refer to [Calibration Setup](#) to apply gas.
6. When calibration is complete turn off gas and disconnect the hose from the calibration cap and regulator.
7. Ensure the gas cylinder is stored according to the manufacturer's specifications.

Calibration Setup

The following calibration procedures are written as calibration performance is intended. If an error or failure occurs, refer to [Calibration Troubleshooting](#).

⚠ Caution

Only calibrate in a fresh air environment and in a safe area. Do not calibrate the detector during or immediately after charging.

Note

Calibration can be aborted at any time. To abort calibration, press ○. The following screen displays.



Setting Span Gas Concentration Values

1. Activate the detector and allow startup to complete.
2. Connect the IR Link to the computer
3. Insert the IR Link into the IR interface on the back of the detector.
4. On the PC, open and log into Safety Suite Device Configurator.
5. From the Device list view, click on the device you want to configure.

6. The window shows the detector's current settings.
7. Refer to [Calibration Gas Concentration](#) for span gas values.
8. Ensure the sensors to be calibrated are enabled in Safety Suite Device Configurator.
9. Select the concentration value(s) in the **Sensors** tab for each sensor. The values entered in Safety Suite Device Configurator must match the gas concentration values on the gas cylinder.
10. Click **SAVE** to save the settings to the detector.

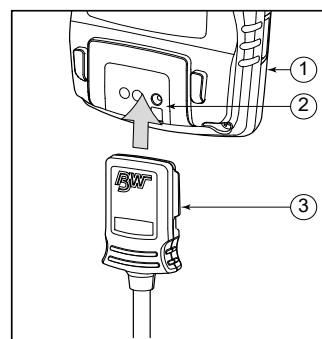

GasAlertMicroClip
Calibration

Connecting to the IR Link

Table 12: Connecting to the IR Link

Item	Description
1	Detector
2	IR and charger interface
3	IR Link

Calibrating with the IR Link

⚠ Caution

Only calibrate in a fresh air environment and in a safe area. Do not calibrate the detector during or immediately after charging.



To calibrate the detector with the IR Link, complete the following procedure:

1. Complete steps #1-10 under Setting Span Gas Concentration Values.
2. Click on the device to be calibrated.
3. From the top options click on **Start Bump/Cal**
4. Set the parameters for each gas to be calibrated.
5. Click **START TEST**. The detector begins calibration. Refer to [Auto Zero and Oxygen Sensor Calibration](#).

Calibration Procedure

⚠ Caution

Only calibrate in a fresh air environment and in a safe area. Do not calibrate the detector during or immediately after charging.

1. Press and hold . The detector performs the **OFF** countdown. Continue holding  as the detector briefly deactivates.



2. The detector then reactivates and performs the **CAL** countdown. Continue holding  until the **CAL** countdown is complete.



Note

If  is not held for the entire countdown, the detector will deactivate.

Auto Zero and Oxygen Sensor Calibration

Note

Do not apply calibration gas until **APPLY GAS** displays, otherwise the auto zero function will fail.

- AUTO-ZERO** flashes while the detector zeroes the combustible and toxic sensors, and calibrates the oxygen sensor.

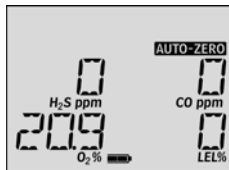

When auto zero is complete, the detector beeps twice.

Auto Zero Successful: If the sensors successfully zero, the detector proceeds to the [Auto Span](#) function.

Auto Zero Unsuccessful: If the sensors fail auto zero, an error message displays showing which sensor failed. Refer to [Calibration Troubleshooting](#).



Auto Span

- When auto zero is complete, **APPLY GAS** displays.



- Attach the calibration cap to the detector. Refer to [Figure 7](#). Open the valve on the regulator and apply gas at a flow rate of 250-500 ml/min.

AUTO-SPAN flashes and **AUTO-SPAN** displays

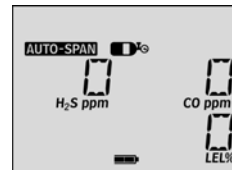

GasAlertMicroClip Calibration

When a sufficient amount of gas has been detected (approximately 30 seconds after the gas has been applied), the detector beeps once, **AUTO-SPAN** flashes, and  remains lit while the detector completes the span (approximately 2 minutes).

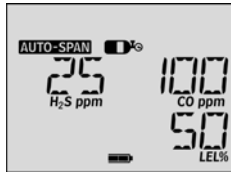

Successful Span

If the sensors have spanned successfully, the detector beeps and the calibration procedure continues.

Unsuccessful Span

If any sensors fail the span, the following screen displays. Refer to [Calibration Troubleshooting](#).



Calibration Due Date

Note

If a sensor fails calibration, the next due date for that sensor will not reset. Refer to [Calibration Troubleshooting](#).

- After calibration is complete, **CAL DUE** displays and all successfully calibrated sensors automatically reset the calibration due dates according to the calibration intervals in Safety Suite Device Configurator.

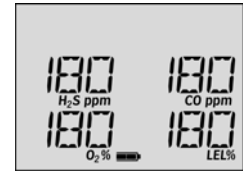

- The number of days that displays is when the next sensor calibration should be performed.



Failed Sensor Past Calibration Due Date: If a sensor fails the span and it is past the calibration due date, the following three screens display.



1. Press \bigcirc to acknowledge the warning. The detector returns to normal operation.

Note

A negative number indicates that sensor is overdue for a calibration.

Verification

1. After calibration is complete and the detector returns to normal operation, verify the calibration using a gas cylinder other than the one used for calibration.
2. The gas concentration should not exceed the sensor's detection range. Confirm the LCD shows the expected concentration.
3. To ensure the readings are accurate, apply the verification gas for the same amount of time as was applied to the sensor when it was calibrated.

Example: H₂S span time 2 minutes therefore, apply verification gas for 2 minutes.

GasAlertMicroClip
Datalogs

Datalogs

The detector records various information that can be compiled to create a report. The detector is capable of storing 16 hours of information (when recording a datalog every 15 seconds). When the memory is full, the detector replaces the oldest datalogs with the most recent datalogs

Event Logs

The detector records the 10 most recent gas alarm events. The following information is recorded:

- Serial number of the detector
- Start time of alarm
- Type, level and duration of alarm
- Peak exposure level (ppm or %)
- Status of the sensor

Downloading Datalogs and Event Logs

The datalog and event log files can only be downloaded to a PC using an IR Link or the IntelliDoX docking module. Refer to the *Safety Suite Device Configurator User's Guide* or *IntelliDoX User Manual*.

Software Requirements

To create spreadsheet reports of event logs, datalogs, and bump and calibration results, the following software applications are required:

- Safety Suite Device Configurator, and
- Microsoft Excel.

Maintenance

To maintain the detector in good operating condition, perform the following basic maintenance as required.

- Calibrate, bump check, and inspect the detector at regular intervals.
- Maintain an operations log of all maintenance, bump checks, calibrations, and alarm events.
- Clean the exterior with a soft damp cloth. Do not use solvents, soaps, or polishes.
- Do not immerse the detector in liquids.

Battery Cautions

⚠ Warning

To avoid personal injury and/or property damage, adhere to the following:

- The detector must be deactivated to charge the battery.
- Charge the battery immediately when the detector emits a low battery alarm. Refer to [Charging the Battery](#).
- Charge the battery in a safe area that is free of hazardous gas in temperatures of 32°F to 113°F (0°C to 45°C).
- Charge the battery using the Honeywell Multi-Unit Cradle Charger or charger adapter only. Do not use any other charging adapters. Failure to adhere to this caution can lead to fire and/or explosion.
- The charging adapter is voltage specific to your region. Use of the charging adapter outside your region will damage the charger and the detector.
- Do not calibrate the detector during or immediately after charging the battery.

- The battery can only be replaced by the manufacturer. Failure to adhere to this caution can lead to fire and/or explosion.
- **Warning:** The GasAlertMicroClip uses a lithium battery that may present a risk of fire or chemical burn hazard if misused. Do not disassemble, heat above 212° (100°C), or incinerate.
- **Warning:** Lithium polymer cells exposed to heat at 266°F (130°C) for 10 minutes can cause fire and/or explosion.

GasAlertMicroClip
Maintenance

Charging the Battery

To charge the battery, refer to [Figure 8](#), [Table 13](#), and the following procedures (1-8).

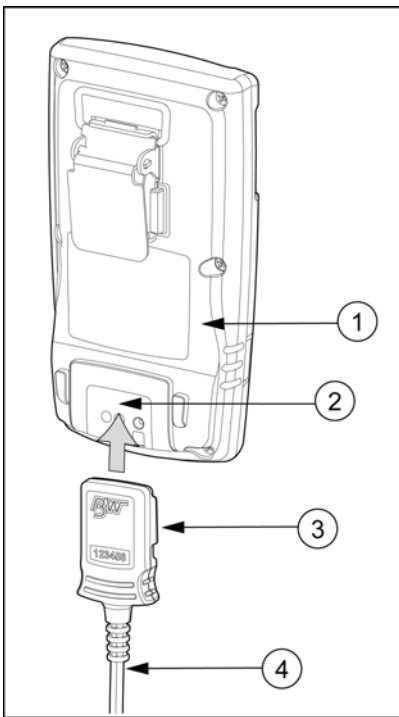

Figure 8. Connecting the Charging Adapter

Table 13. Connecting the Charging Adapter

Item	Description
1	Detector
2	IR and charger interface
3	Charging adapter
4	Charging cable

⚠ Warning

The detector must be charged in a safe area that is free of hazardous gas in temperatures of 32°F to 113°F (0°C to 45°C).

1. Deactivate the detector.
2. Plug the charging adapter into an AC outlet.

⚠ Caution

The charging adapter is voltage specific to your region. Use of the charging adapter outside your region will damage the charger and the detector.

3. Attach the charging adapter to the charger interface. Refer to [Figure 8](#).
4. Allow the battery to charge per battery specifications. The charging indicator flashes on the LCD while the detector is being charged.

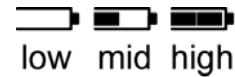

5. When charging is complete, the charging indicator stops flashing and displays  to indicate a full charge. Remove the charging adapter and activate the detector.

If the battery indicator does not display, refer to [Troubleshooting](#).

6. Charge the battery after each workday.

Note

To reach full battery capacity, allow the battery to fully charge and fully discharge three times.

Charging the detector in temperatures above 113°F (45°C) will greatly reduce the number of charges the detector can accept.

The detector may be warm immediately following charging. This is normal.

Replacing a Sensor or Sensor Filter

⚠ Warning

To avoid personal injury, only use sensors that are specifically designed for the detector. Refer to [Replacement Parts and Accessories](#).

Use proper ESD handling practices.

- Each sensor has a high degree of resistance to common vapors and gases. To clear a sensor, move the detector to a non-hazardous environment and wait 10 to 30 minutes.
- Do not expose a sensor to vapors of inorganic solvents such as fumes from paint thinners, or organic solvents such as benzoic acids and acrylic acids.
- Ensure hands are clean or wear gloves before handling components.

To replace a sensor or sensor filter, refer to

- [Table 14](#),
- [Figure 11](#),
- Figure 12
- [Figure 13](#), and
- the following procedures.

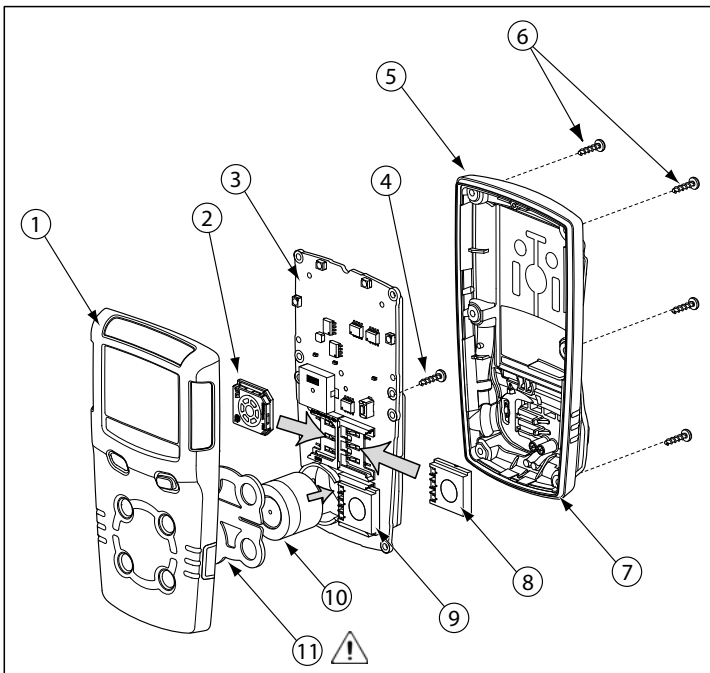

Figure 9. Replacing a Sensor or Sensor Filter

Table 14. Replacing a Sensor or Sensor Filter

Item	Description
1	Front shell
2	Combustible (LEL) sensor
3	PCB
4	PCB screws (2)
5	Rear shell
6	Machine screws (6)
7	Sealing rib
8	Carbon monoxide (CO) sensor
9	Hydrogen sulfide (H ₂ S) sensor
10	Oxygen (O ₂) sensor
11	Sensor filter

Removing the back shell

1. Deactivate the detector. On a clean surface, place the detector face down.
2. Remove the six machine screws on the rear shell.
3. Remove the back cover by lifting the top and the bottom upwards simultaneously to prevent damaging the charger pins.

Replacing the Sensor Filter

1. Note the placement of the PCB to ensure it is replaced correctly. Remove the two screws on the PCB. Remove the PCB carefully.

⚠ Caution

Ensure no damage occurs to the battery.

2. Remove the old sensor filter. It may be stuck to the sensors.
3. Pull the liner tab, if present, to remove the liner from the sensor filter. Do not fold the sensor filter.
4. Verify that the black gasket is facing the front shell and the large diameter circle on the gasket is aligned with the large circle on the front shell.
5. Place the gasket as shown, and then use your fingers to apply even pressure to the entire gasket.
6. To reassemble the detector, refer to [Reassembling the detector](#).

Figure 10. Liner Tab

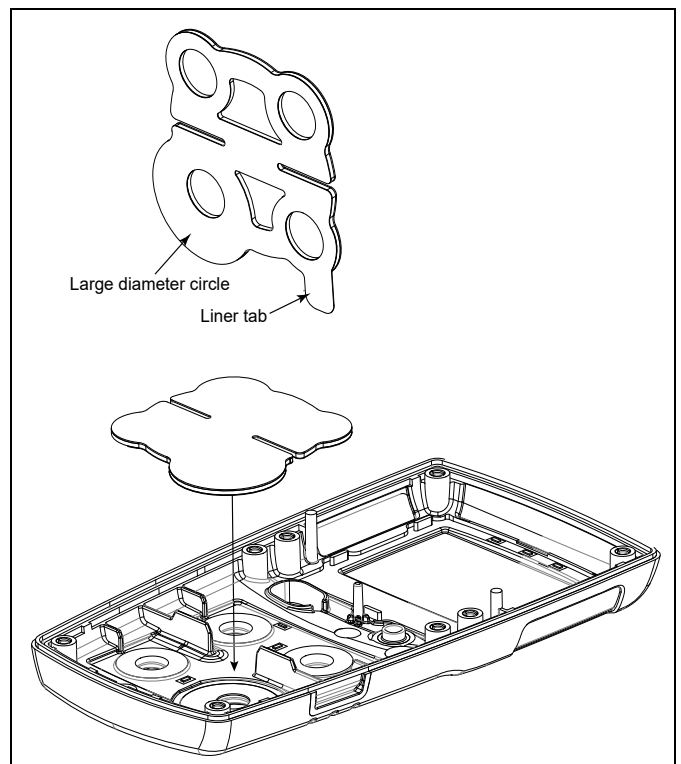

Replacing the H₂S, CO, and LEL sensor

1. Note the placement of the PCB to ensure it is replaced correctly. Remove the two screws on the PCB. Remove the PCB carefully.

⚠ Caution

Ensure no damage occurs to the battery.

If the sensor filter is stuck to the sensors, remove and replace the sensor filter into the front shell.

2. Slide the sensors out.

Note

Detectors that are configured for 1, 2, or 3 gases may contain a dummy sensor in one of the four sensor locations.

3. Insert the new sensor(s). For sensor positioning, refer to Figure 11.

Note: The Oxygen sensor is located in the bottom left corner of the detector.

4. To complete the detector, refer to [Reassembling the detector](#).

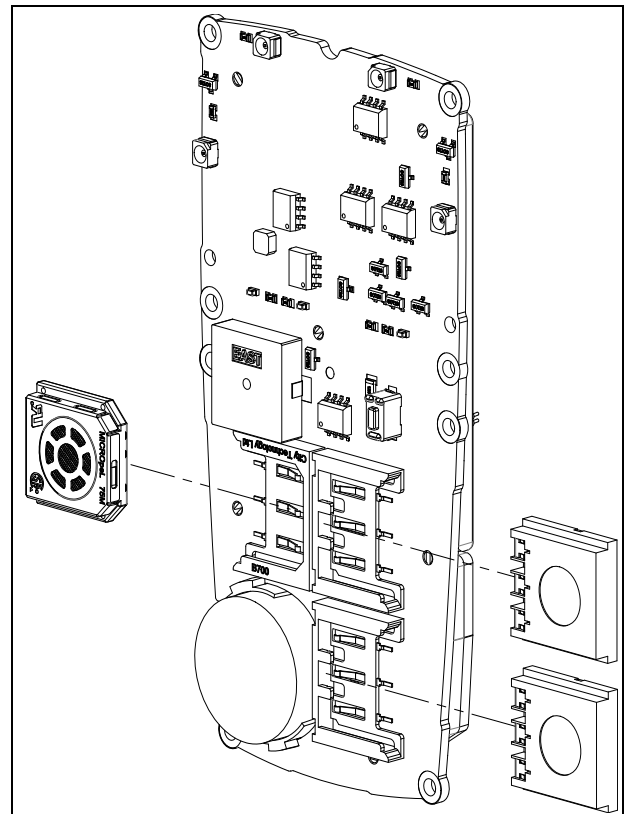
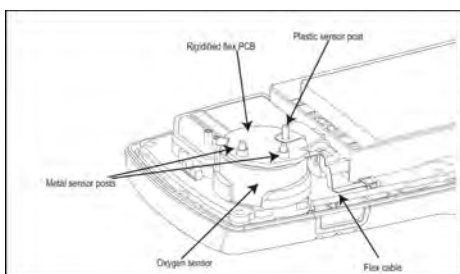

Figure 11. Sensor Positioning

Replacing the Oxygen Sensor XT and XL



Note: Detectors that are configured for 1, 2, or 3 gases may contain a dummy sensor in one of the four sensor locations.

1. Gently remove the circular rigidified flex PCB atop the sensor from the metal sensor posts. Take care not to tear the flex cable.
2. Note the placement of the PCB to ensure it is replaced correctly. Remove the two screws on the PCB.

⚠ Caution

Ensure no damage occurs to the battery.

3. Lift the PCB straight up. The oxygen sensor will stay in the front shell. Remove the sensor.
4. On roughly the same spot on the front shell, place the new sensor. Lower the PCB over the oxygen sensor.
5. Carefully replace the circular rigidified flex PCB atop the metal sensor posts. Ensure the plastic sensor post is inserted into the clear plastic hole. Take care not to tear the flex cable.
6. Press down to secure the circular rigidified flex PCB atop the metal sensor posts. Take care not to press down too hard and accidentally activate the detector.
7. To complete the detector, refer to [Reassembling the detector](#).

Replacing the Oxygen Sensor X3

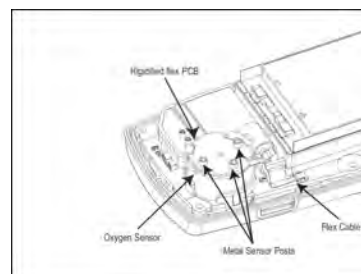

Note: Detectors that are configured for 1, 2, or 3 gases may contain a dummy sensor in one of the four sensor locations.

1. Gently remove the circular rigidified flex PCB atop the sensor from the metal sensor posts. Take care not to tear the flex cable.
2. Note the placement of the PCB to ensure it is replaced correctly. Remove the two screws on the PCB.

⚠ Caution

Ensure no damage occurs to the battery.

3. Lift the PCB straight up. The oxygen sensor will stay in the front shell. Remove the sensor.
4. On roughly the same spot on the front shell, place the new sensor. Lower the PCB over the oxygen sensor.
5. Carefully replace the circular rigidified flex PCB atop the metal sensor posts. Take care not to tear the flex cable.
6. Press down to secure the circular rigidified flex PCB atop the metal sensor posts. Take care not to press down too hard and accidentally activate the detector.
7. To complete the detector, refer to [Reassembling the detector](#).

Reassembling the detector

1. To re-assemble the detector, perform the following:
 - Verify the PCB is seated correctly and inserted exactly as it was removed (sensors facing the front shell).
 - Replace the two PCB screws.
 - Visually inspect the battery to ensure no damage has occurred.
 - When replacing the rear shell, ensure the charging pins (bottom of inside rear shell) are aligned with the corresponding holes on the PCB. If the contact pins are bent, the battery will not charge correctly.

Note

Ensure the rib on the interior rear shell ① inserts between the battery and the PCB ②.

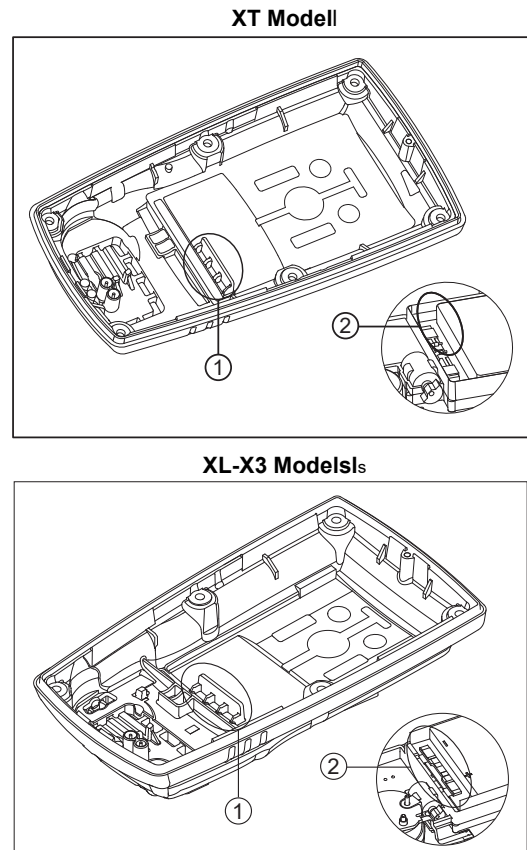

Figure 14. Replacing the Rear Shell

- Press the front and rear shells together firmly to ensure a proper seal. Ensure the front and rear shell have a uniform, tight 1/16 in (1 mm) seal on all sides of the detector.
 - When replacing the screws, they must be seated properly to prevent cross threading. Turn the screw counter-clockwise until a click is heard and then begin tightening the screw clockwise.
2. New sensors must be calibrated. Activate the detector and calibrate the sensor(s). Refer to [Calibration](#).

Troubleshooting

If a problem occurs, refer to the solutions in the Troubleshooting section. If the problem persists, contact

Table 15. Troubleshooting

Problem	Possible Cause	Solution
Startup		
The detector does not activate.	Depleted battery	Charge battery. Refer to Charging the Battery .
	Damaged or defective detector	Contact.
The detector enters alarm immediately when activated.	Sensor needs to stabilize	Used sensor: wait 60 seconds New sensor: wait 5 minutes (The oxygen sensor in the X3 needs 60 minutes to stabilize)
	Low battery alarm	Charge battery. Refer to Charging the Battery .
	Detector requires calibration	Calibrate the detector. Refer to Calibration .
	Hazardous environment	Leave the area immediately. Deactivate and reactivate in a safe area that is free of hazardous gas, in an atmosphere of 20.9% oxygen.
The activation self-test fails.	General fault	Contact.
	Sensor failure	Replace the sensor. Refer to Replacing a Sensor or Sensor Filter .
Detector automatically deactivates during startup.	Battery power too low to operate	Charge battery. Refer to Charging the Battery .
	Force Calibration When Overdue option is enabled and calibration is not attempted	Calibrate the sensor(s) immediately. Refer to Calibration .
	Force Bump When Overdue option is enabled and a bump test is not attempted	Bump test the sensor(s) immediately. Refer to Bump Test .

Table 15. Troubleshooting





Problem	Possible Cause	Solution
Detector Operation		
Detector does not display expected gas readings after activation self-test.	Sensor not stabilized	Used sensor: wait 60 seconds New sensor: wait 5 minutes (The oxygen sensor in the X3 needs 60 minutes to stabilize)
	Sensor(s) requires calibration	Calibrate the sensor(s). Refer to Calibration .
	Target gas is present	Detector is operating properly. Use caution in suspect areas.
Detector does not respond to button.	Battery is depleted	Charge battery. Refer to Charging the Battery .
	Detector is performing operations that do not require user input	Button operation restores automatically when the operation ends.
Detector does not accurately measure gas.	Sensor(s) requires calibration	Calibrate the sensors. Refer to Calibration .
	Detector is colder/hotter than ambient gas	Allow the detector to attain ambient temperature before use.
	Sensor filter is blocked	Replace the sensor filter. Refer to Replacing a Sensor or Sensor Filter .
Detector does not enter into alarm.	Alarm setpoint(s) defined incorrectly	Reset alarm setpoints. Refer to Factory Gas Alarm Setpoints and Sensor Configuration .
	Alarm setpoint(s) set to zero	Reset alarm setpoints. Refer to Factory Gas Alarm Setpoints and Sensor Configuration .
	Detector is in calibration mode	Complete the calibration procedure.

GasAlertMicroClip
 Troubleshooting

Table 15. Troubleshooting

Problem	Possible Cause	Solution
Detector intermittently enters alarm without reason.	Ambient gas levels are near alarm setpoint or the sensor is exposed to a puff of the target gas	Detector is operating normally. Use caution in suspect areas. Check the peak (maximum) gas exposure reading.
	Alarm setpoints defined incorrectly	Reset alarm setpoints. Refer to Factory Gas Alarm Setpoints and Sensor Configuration .
	Detector requires calibration	Calibrate the sensors. Refer to Calibration .
	Missing or faulty sensor(s)	Replace the sensor. Refer to Replacing a Sensor or Sensor Filter .
Features and options are not operating as expected.	Changes have been made in Safety Suite Device Configurator	Verify settings in Safety Suite Device Configurator are correct.
Charging		
Battery has been charging for 3+ hours (XT model) or 6+ hours (XL-X3 models). The charging indicator on the detector LCD shows the battery is still charging.	Battery is trickle charging	Battery is fully charged and ready for operation.
Battery indicator does not display when charging.	Detector is depleted below normal levels	Charge the battery for 8 hours. Detector LEDs may light during first 5 hours. This is normal. If the battery indicator does not light after charging for 8 hours, contact
When detector is activated after charging, the battery indicator does not display.	Battery is defective	Contact.



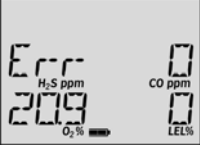

Startup Troubleshooting

Error Screen	Problem	Solution	Error Screen	Problem	Solution
	Sensor Error The sensor failed during the self-test.	Calibrate the sensor(s). Refer to Calibration . Reactivate the detector. If error displays again, replace the sensor. Refer to Replacing a Sensor or Sensor Filter .		IR Lock Enabled If the IR Lock screen displays, an IR device is required to calibrate the sensors.	Perform calibration using the IR Link with Safety Suite DC software, or insert the detector into the IntelliDoX module. Refer to Cal Lock (Calibration IR Lock) in User Options and Calibration .
	Calibration Overdue Displays when calibration is overdue. If the Force Calibration When Overdue option is enabled, the sensor(s) must be calibrated to enter normal operation.	Press \bigcirc to continue and calibrate the sensor(s) immediately. Refer to Calibration . If the IR Lock enabled screen displays, the IntelliDoX module or the IR Link with Safety Suite Device Configurator must be used to calibrate.		Bump Test Fail A bump test has just been performed. The detector is prompting for another bump test because a sensor(s) has failed.	Perform another Bump Test . Ensure the cylinder is not empty and that the cylinder is not past the expiry date. Ensure the regulator is fully opened to apply gas. If Bump Check Today displays again, calibrate the sensors. Refer to Calibration . If the calibration is unsuccessful, refer to Replacing a Sensor or Sensor Filter .
	Forced Calibration If Force Calibration When Overdue is enabled, the sensors must be calibrated to enter normal operation.	Press and hold \bigcirc to calibrate the sensors, or press \bigcirc and release to deactivate the detector. Refer to Calibration . If the IR Lock enabled screen displays, an IR device must be used to calibrate.		Sensor Fail A sensor has failed during the startup self-test.	Perform a Bump Test and reactivate the detector. If the sensor fails again, perform Calibration . Reactivate the detector again. If the sensor still does not pass, refer to Replacing a Sensor or Sensor Filter .

GasAlertMicroClip

Calibration Troubleshooting

Calibration Troubleshooting

Error Screen	Problem	Solution	Error Screen	Problem	Solution
	Auto-zero Unsuccessful H ₂ S, CO, or LEL sensor fails to auto-zero, or O ₂ sensor fails to calibrate.	Attempt calibration again. Refer to Calibration . If ERROR displays again, replace the sensor. Refer to Replacing a Sensor or Sensor Filter .		No Gas Detected If the gas is not detected about 30 seconds after the APPLY GAS message is displayed, the detector fails the calibration.	Ensure the sensor is enabled. Verify gas cylinder is not empty or past the expiration date. Check/replace the regulator. Attempt calibration again. If the calibration fails again, refer to Replacing a Sensor or Sensor Filter .
	Auto Span Unsuccessful H ₂ S, CO, or LEL, or O ₂ sensor fails to auto-span.	Ensure sensor is enabled. Verify gas cylinder is not empty or past the expiration date. Check/replace the regulator. Attempt calibration again. If the sensor fails the span again, refer to Replacing a Sensor or Sensor Filter .		Calibration Due Date Overdue A sensor displays a negative number for a next due date after calibration is performed.	Calibration for the sensor was unsuccessful. The due date will not reset. Attempt calibration of the sensor again. If still unsuccessful, refer to Replacing a Sensor or Sensor Filter . Calibrate the new sensor immediately.
	IR Lock Enabled IR-Lock displays when calibration is attempted.	Perform calibration using the IR Link with Safety Suite DC software, or insert the detector into the IntelliDoX module. Refer to Cal Lock (Calibration IR Lock) in User Options and Calibration.			

Replacement Parts and Accessories

⚠ Warning

To avoid personal injury and/or damage to the detector, use only the specified replacement parts.

To order parts or accessories listed in the following table, contact.

Table 16. Replacement Parts and Accessories

Model No.	Description
Sensors	
SR-W-MP75C	MICROpeL combustible (LEL) sensor
SR-H-MC	MICROceL hydrogen sulfide (H ₂ S) sensor
SR-M-MC	MICROceL carbon monoxide (CO) sensor
SR-DUMM1	Replacement dummy O ₂ sensor
SR-TOX-MC-DUMM	Replacement dummy CO or H ₂ S sensor
SR-W-MC-DUMM	Replacement dummy LEL sensor
SR-X3P	Replacement O ₂ Sensor (Compatible with X3 only)
SR-X2V	Replacement O ₂ sensor (Compatible with XT and XL only)
Sensor filters	

Model No.	Description
MC2-SS	Replacement quad sensor screens (Kit of 2).
MC2-SS-K1	Replacement quad sensor screens (Kit of 10)
MC-AF-1	Auxiliary adapter (filters not included)
MC-SS-AF-K1	Auxiliary kit (adapter with 10 filters)
Regulator	
Reg-0.5	Regulator (0.5 l/min)
Gas Cylinders	
CG-Q58-4	Quad gas cylinder: CH ₄ (2.5%), O ₂ (18.0%), H ₂ S (25 ppm), CO (100 ppm), bal. N ₂ (58 l)
CG-Q34-4	Quad gas cylinder: CH ₄ (2.5%), O ₂ (18.0%), H ₂ S (25 ppm), CO (100 ppm), bal. N ₂ (34 l)
CG-T34	Dual gas cylinder: 50% LEL (CH ₄ 2.5%) O ₂ (20.9%), bal. N ₂ (34 l)
CK-Q58-4	Quad calibration kit with regulator, quad gas cylinder (CG-Q58-4), hose, and carrying case
G0042-H25	Single gas cylinder: H ₂ S (25 ppm), bal. N ₂ (58 l)

GasAlertMicroClip

Replacement Parts and Accessories

Model No.	Description
CG2-M-200-103	Single gas cylinder: CO (100 ppm), bal N ₂ (103 l)
CG-BUMP1	Bump alarm gas aerosol: CH ₄ (2.5%), O ₂ (10%), H ₂ S (40 ppm), CO (200 ppm)
Charger and Accessories	
MC2-CO1-MC5*	Multi-unit (5) cradle charger
GA-PA-1-MC5*	Multi-unit wall outlet power adapter
GA-PA-3	12-24 VDC direct-wire power adapter
GA-PA-1*	Replacement wall outlet power adapter
GA-VPA-1	12-24 VDC Vehicle power adaptor
Confined space kit	
MC-CK-DL	Deluxe confined space kit for the GasAlertMicroClip products.
MC-CK-CC	Carry case and foam insert for the GasAlertMicroClip products
IntelliDoX and Module	
DOCK2-2-1C1P-00-G*	IntelliDoX Automatic Test and Calibration System, GasAlertMicroClip XT/XL module, and charging cable
DOCK2-2-1P-00-G*	IntelliDoX Automatic Test and Calibration System and GasAlertMicroClip XT/XL module

Model No.	Description
DOCK2-0-1P-00-G	GasAlertMicroClip XT/XL docking module
Datalogging Accessories	
GA-USB1-IR	IR Connectivity Kit (with Safety Suite Device Configurator)
Sampling/Testing Equipment	
MC-TC-1	Replacement test cap
MC-AS01	Manual aspirator pump kit with probe (1 ft. / 0.3 m)
MC-TC-1	Calibration cap
Carrying Accessories	
GA-NS-1	Neck strap with safety release
GA-LY-1	Short strap 6 in. (15.2 cm)
GA-ES-1	Extension strap 4 ft. (1.2 m)
GA-CH-2	Chest harness
MC2-LC-1	Black leather PVC carrying holster for XT
Miscellaneous	
MCX3-FC1	Replacement front enclosure - Yellow (Compatible with X3 only)

Model No.	Description
MCX3-FC1B	Replacement front enclosure - Black (Compatible with X3 only)
MCX3-BC1	Replacement back enclosure - Yellow (Compatible with X3 only)
MCX3-BC1B	Replacement back enclosure - Black (Compatible with X3 only)
MCX3-FPCB1	Replacement flex PCB (Compatible with X3 only)
MCX3-MPCB1	Replacement main PCB and battery (Compatible with X3 only)
MCXL-FC1 MC2-FC1	Replacement front enclosure – Yellow (compatible with XL only)
MCXL-FC1B MC2-FC1B	Replacement front enclosure – Black (compatible with XL only)
MCXL-BC1 MC2BC1	Replacement back enclosure – Yellow (compatible with XL only)
MCXL-BC1B MC2-BC1B	Replacement back enclosure – Black (compatible with XL only)
MC2-FPCB1	Replacement flex PCB (for XT)

Model No.	Description
MCXL-MPCB1 MC2-MCPCB1	Replacement main PCB and battery (compatible with XL only)
MC-LCD-K1	Replacement LCD (for XT)
MC-SCREW-K1	Replacement screw kit (for XT)

**Add one of the following applicable suffixes to the end of the order number to ensure power adapter is correct for region.*

-UK for United Kingdom

-EU for Europe,

-AU for Australia/China,

-NA for North America,

-CN for China,

-BR for Brazil,

GasAlertMicroClip
Specifications

Specifications

Instrument dimensions:

XT: 11.25 x 6.00 x 2.89 cm (4.4 x 2.4 x 1.1 in.)

XL-X3: 11.25 x 6.00 x 3.22 cm (4.4 x 2.4 x 1.2 in.)

Weight:

XT: 170 g (6.0 oz.)

XL: 190 g (6.7 oz.)

X3: 179 g (6.3 oz.)

Operating temperature: -4°F to +122°F (-20°C to +50°C)

Storage temperature: -40°F to +122°F (-40°C to +50°C)

Operating humidity: 0% to 95% relative humidity (non-condensing)

Alarm setpoints: May vary by region and are user defined. All setpoints automatically display during the startup self-test

Detection range:

H₂S: 0 – 100 ppm (1 / 0.1 ppm increments)

CO: 0 – 500 ppm (1 ppm increments)

O₂: 0 – 30.0% vol. (0.1% vol. increments)

Combustible (LEL): 0% to 100% LEL (1% LEL increments) or 0.0% to 5.0% v/v methane

Alarm conditions: TWA alarm, STEL alarm, low alarm, high alarm, multi-gas alarm, over limit (OL) alarm, low battery alarm, confidence beep, automatic deactivation alarm

Audible alarm: 95 dB at 30 cm (1 ft.) (100 dB typical) variable pulsed beeper

Visual alarm: Red light-emitting diodes (LED)

Display: Alphanumeric liquid crystal display (LCD)

Backlight: Activates when the button is pressed and deactivates after 5 seconds; also activates during an alarm condition

Self-test: Initiated upon activation

Calibration: Automatic zero and automatic span

Oxygen sensor: Automatic span upon activation (enable/disable)

User field options: Startup message, Confidence Beep, latching alarms, enable/disable safe display mode, oxygen measurement, combustible sensor measurement, sensor disable, define calibration interval, force calibration, calibration lock, force bump, define bump interval, bump due lock, stealth mode, low alarm acknowledge, language selection, enable/disable automatic oxygen calibration, enable/disable auto zero at startup, define alarm setpoints, span concentration values, define STEL calculation period, IntelliFlash, and Confidence Beep and IntelliFlash Interval

Table 17: Battery Operating Time

	XL-X3	XT
Typical Battery Life*	18 hours Recharges in less than 6 hours	10 hours Recharges in less than 4 hours
Cold Weather Battery Life**	12 hours at -4°F / -20°C	
<p>*Approximately 20% capacity loss is normal with lithium polymer batteries after 500 charge cycles. Refer to the Operator's Manual for additional information.</p> <p>**Battery is guaranteed to have 12 hour runtime during warranty period under normal operating temperature of -4°F / -20°C to 122°F/50°C.</p>		

1ppm = 1 µmol/mol

Year of manufacture: The detector's year of manufacture is determined from the serial number. The second and third number after the letters determines the year of manufacture

E.g.: KA410-000001 = 2010 year of manufacture

Approved battery:

Lithium-ion polymer (non-replaceable), conforming to standards EN 60079-0, EN 60079-11, UL913, CSA C22.2 No. 157, UL 1642

Rechargeable battery

Lithium polymer -20°C ≤ Ta ≤ +50°C

Battery charger: GasAlertMicroClip charging adapter

Temperature code

T4

⚠ Warning

Charge only in a safe area that is free of hazardous gas and within temperatures of 32°F to 113°F (0°C to 45°C) First-time charge:

XT: 2-3 hours

XL-X3: 5-6 hours

Normal charge:

XT: 2-3 hours

XL-X3: 5-6 hours

Warranty XT-XL: 2 years including sensors

Warranty X3: 3 years including sensors

Guarantee: Battery is guaranteed to have a 12 hour runtime during warranty period under the normal operating temperature of -4°F/-20°C to 122°F/50°C

Approvals:

Approved by CSA to both U.S. and Canadian Standards

CAN/CSA C22.2 No. 157 and C22.2 152

ANSI/UL – 913 and ANSI/ISA – 12.13.01 Part 1

CSA Class I, Division 1, Group A, B, C, and D

ATEX CE 0539 Ⓢ II 1G Ex da ia IIC T4 Ga DEKRA 19ATEX0025

EN 60079-0, EN 60079-1, EN 60079-11, EN 60079-26

IECEX Ex da ia IIC T4 Ga IECEx CSA 05.0015

IEC 60079-0, IEC 60079-1, IEC 60079-11, IEC 60079-26

KTL GasAlertMicroClip XT:12-KB4BO-0053 GasAlertMicroClip

XL:14-KB4BO-0659X

GasAlertMicroClip X3:15-KA4BO-0307X³

Indication Error LEL: ± 5% FS: H2S: ± 5x 10-6: CO: ± 10%: O2: ± 5% FS

This equipment has been tested and found to comply with the limits for a Class B digital device, pursuant to Part 15 of the FCC Rules and

GasAlertMicroClip Specifications

ICES-003 Canadian EMI requirements. These limits are designed to provide reasonable protection against harmful interference in a residential installation. This equipment generates, uses and can radiate radio frequency energy and, if not installed and used in accordance with the instructions, may cause harmful interference to radio communications. However, there is no guarantee that interference will not occur in a particular installation. If this equipment does cause harmful interference to radio or television reception, which can be determined by turning the equipment off and on, the user is encouraged to try to correct the interference by one of more of the following measures:

- Reorient or relocate the receiving antenna.
- Increase the separation between the equipment and receiver.
- Connect the equipment into an outlet on a circuit different from that to which the receiver is connected.
- Consult the dealer or an experienced radio/TV technician for help.

General Datalogger Specifications

Storage: 16 hours at 15-second intervals

Memory type: Wraparound memory ensures most recent data is always saved

Datalog Interval: The default interval is one reading every 15 seconds. The user has the option to change the intervals to rates from 1 to 120 seconds.

Data recorded: All sensor readings, all alarm conditions, calibrations, event flags, battery status, sensor status, confidence beep activation, and detector status with the time and date for each reading and unit serial number

Operation: Requires no user intervention (automatic)

Compatible with: Desktop PC computer or laptop

Operating system: Windows 2000 or higher

Download via: IR device (IR Link adapter or IntelliDoX docking module)

Software required:

- Safety Suite Device Configurator application,
- Microsoft Excel (optional) to create custom reports.